

## REFERENCES AND ACCESSORIES

### References

0103010801	ANEMO4403 V3 PULSES OUTPUT M8 LATERAL
0103010802	ANEMO4403 V3 PULSES OUTPUT M8 UNDERSIDE
0103010804	ANEMO4403 V3 PULSES OUTPUT 2,5m CABLE
0103010806	ANEMO4403 V3 PULSES OUTPUT 20m CABLE

### Other devices, ANEMO4403 V3 PULSES Range

#### Heated

0103011301	ANEMO5H25 V3 PULSES OUTPUT M12 UNDERSIDE NO FEMALE CONNECTOR
0103011302	ANEMO5H25 V3 PULSES OUTPUT M12 UNDERSIDE
0103011303	ANEMO5H25 V3 PULSES OUTPUT M12 UNDERSIDE 12m CABLE
0103011304	ANEMO5H25 V3 PULSES OUTPUT M12 UNDERSIDE 25m CABLE

#### Pulses with configurable scale

0103011101	ANEMO4403 V3 NPN OUTPUT 20m CABLE
------------	-----------------------------------

#### Wireless

0103012001	SET ANEMO4403 V3 + RF MODULE V3 FB + WM44-P V3RF 24Vdc
0103012002	SET ANEMO4403 V3 + RF MODULE V3 FB + WM44-P V3 RF 230Vac
0103012003	SET ANEMO4403 V3 + RF MODULE V3 FB + WM44-EVO11 V3 RF IP65 24Vdc
0103012004	SET ANEMO4403 V3 + RF MODULE V3 FB + WM44-EVO11 V3 RF IP65 230Vac
0103012005	SET ANEMO4403 V3 + RF MODULE V3 F/SLB + WM44-P V3 RF 24Vdc
0103012006	SET ANEMO4403 V3 + RF MODULE V3 F/SLB + WM44-P V3 RF 230Vac
0103012007	SET ANEMO4403 V3 + RF MODULE V3 F/SLB + WM44-EVO11 V3 RF IP65 24Vdc
0103012008	SET ANEMO4403 V3 + RF MODULE V3 F/SLB + WM44-EVO11 V3 RF IP65 230Vac

### Displays

0106030501	WM44-P V3 230Vac
0106030502	WM44-P V3 48Vac
0106030503	WM44-P V3 24Vac
0106030504	WM44-P V3 24Vdc NOT INSULATED
0106030505	WM44-P V3 12Vdc NOT INSULATED
0106030601	WM44-SS V3 24Vac
0106030701	WM44-DRM V3 230Vac
0106030702	WM44-DRM V3 48Vac
0106030411	WM44-EVO11 V3 IP 65 24Vdc
0106030412	WM44-EVO11 V3 IP 65 230Vac

### Accessories

0103010505	Stainless steel bracket AISI 304
FE BRIDA ANTENNA	Steel clamps that can be fixed to irregular parts measuring up to 63 x 45 mm
IM BASE ND 32x7	Magnets for flat ferromagnetic surfaces. This fixation system can support up to 90 kg

\*For other references, please contact us.



## ANEMO4403 V3 PULSES OUTPUT

### ANEMO V3 range.

Wind speed sensor designed for different industries and sectors.

ANEMO4403 V3 PULSES OUTPUT has a pulses output proportional to the wind speed given by a reed switch. In this way, the power supply just needs to be enough to detect the contact closing and opening, reducing the power consumption.

Industrial design for extreme conditions

Reed switch pulses output

Measurement range up to 180km/h

Stainless steel bearings

Low power consumption

2 or 3 wire connection to a PLC



Certificado E201129



## APPLICATIONS

ANEMO4403 V3 have been designed to be used in industrial applications: cranes, solar panels, buildings, wind turbines, weather stations...

It is usually connected to speed sensors such as tachometers ( see references WM44-EVO, WM44-P V3, WM44-DRM V3), PLCs or data loggers to display the wind speed and/or set alarms to predefined values or to obtain records during predefined periods of time.

## OPERATION

### Outputs/Inputs

#### Up to 180 km/h of wind speed

**Output:** Dry reed contact, with a series resistance which switches with a frequency proportional to the wind speed (see graphic). It includes an internal capacitor that can be used as a signal filter.

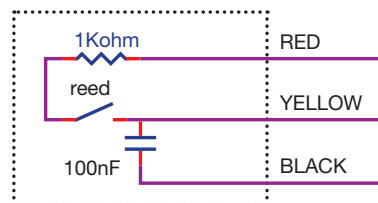

## WIND SPEED / OUTPUT RATIO

The wind speed is given by the function:  
 $\text{Speed (km/h)} = 0.8 * \text{Hz} + 3$

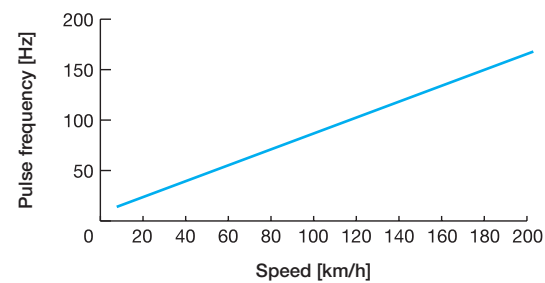

## DIMENSIONS

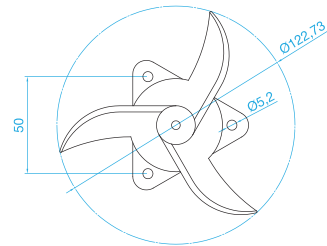

ANEMO4403 V3 CABLE

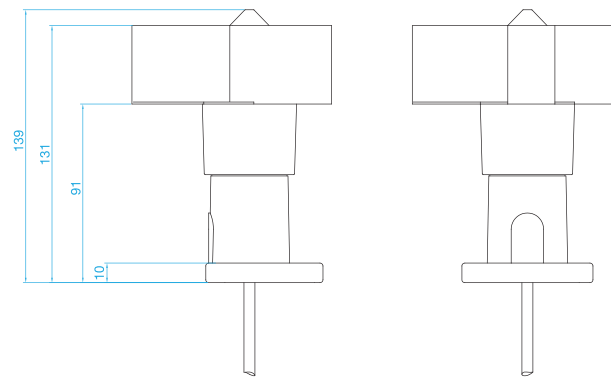

ANEMO4403 V3 M8 LATERAL

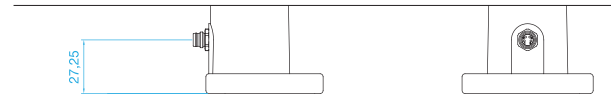

ANEMO4403 V3 M8 UNDERSIDE

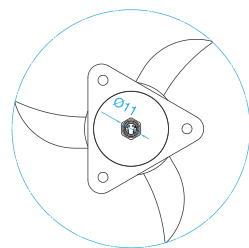
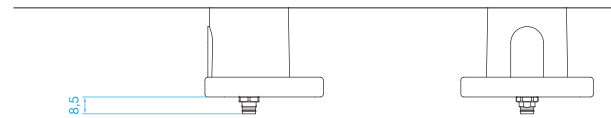

## TECHNICAL SPECIFICATIONS

### Electrical features

Power supply	3...24 Vdc
Maximum current	15 mA
Output	Frequency (pulses)
Type of contact	reed

### Measurements

Range	3-180 km/h
Starting speed	8 km/h
Survival speed	200 km/h
Accuracy	1 km/h (3-15 km/h) 3% (15-180 km/h)
Speed-Hz ratio	Speed (km/h) = 0.8*Hz +3

### General features

Material	PA + FG
Bearings	Stainless steel X65Cr13
Type of connection	See references (back cover)
Weight (with a 20m cable)	1420 g
Weight (without cable)	130 g
Dimensions	125x139 mm
Storage temperature	-35 °C +80 °C
Working temperature without ice	-20 °C +80 °C
EMC	EN 61000-6-2:2001 EN 55022:2001, Class B
Protection	IP65 (UNE 20324:1993)

## CONNECTION EXAMPLES

### 2-wire connection to a display

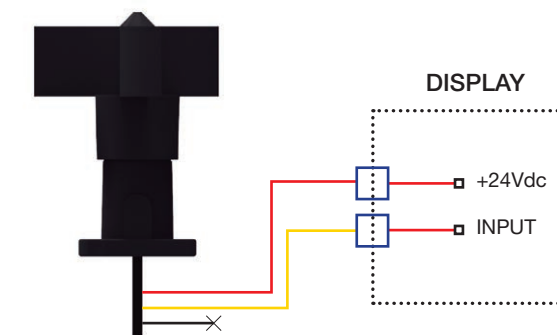

### 3-wire connection to a PLC

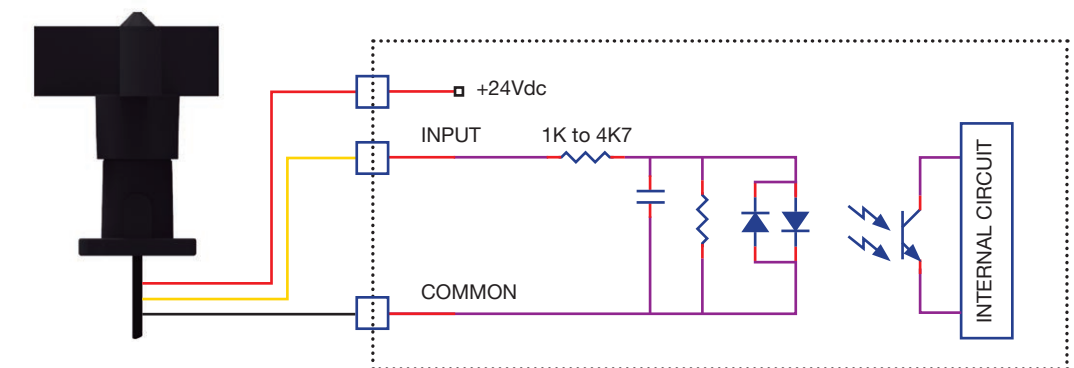

### 3-wire connection to WM44-P V3 display

